

Modern Disc Style Deadbolt

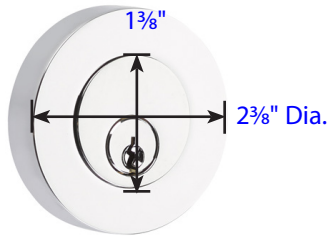

Exterior Trim (8423)
 • Projection is 1 1/2"
 • 8323 same on both sides

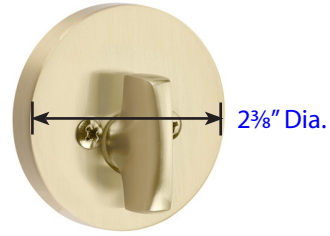

Interior Trim (8423)
 • Projection is 1"
 • Thickness is 5/16"

Square Style Deadbolt

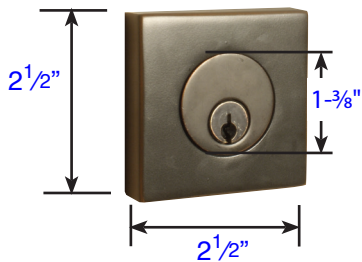

Exterior Trim (8469)
 • Projection is 5/8"
 • 8369 same on both sides

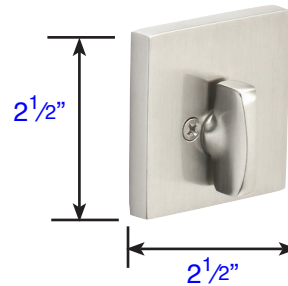

Interior Trim (8469)
 • Projection is 1 1/4"
 • Thickness is 5/16"

Modern Style Deadbolt

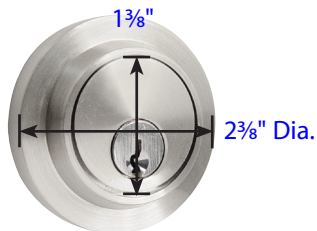

Exterior Trim (8467)
 • Projection is 5/8"
 • 8367 same on both sides

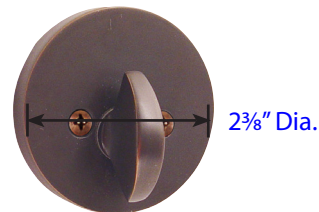

Interior Trim (8467)
 • Projection is 1 1/4"
 • Thickness is 5/16"

Neos Modern Style Deadbolt

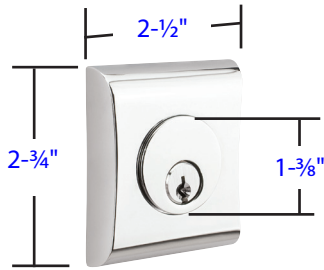

- Exterior Trim (8475)
- Projection is $\frac{5}{8}$ "
 - 8375 same on both sides

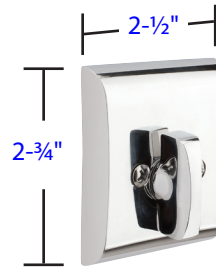

- Interior Trim (8475)
- Projection is 1"
 - Thickness is $\frac{3}{8}$ "

Urban Modern Style Deadbolt

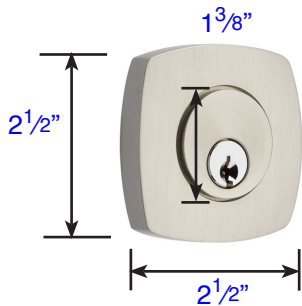

- Exterior Trim (8426)
- Projection is $\frac{1}{2}$ "
 - 8326 same on both sides

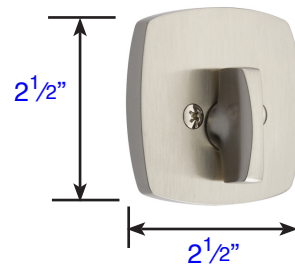

- Interior Trim (8426)
- Projection is $\frac{1}{16}$ "
 - Thickness is $\frac{3}{8}$ "

Quincy Style Deadbolt

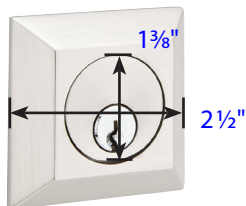

- Exterior Trim (8478)
- Projection is $\frac{1}{2}$ "
 - 8378 same on both sides

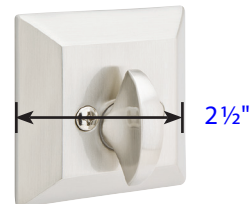

- Interior Trim (8478)
- Projection is $\frac{1}{4}$ "
 - Thickness is $\frac{5}{16}$ "

Wilshire Style Deadbolt

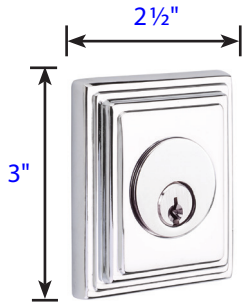

Exterior Trim (8479)
 • Projection is 1/2"
 • 8379 same on both sides



Interior Trim (8479)
 • Projection is 1"
 • Thickness is 5/16"

Regular Style Deadbolt

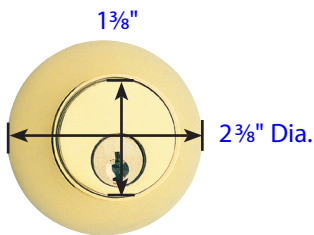

Exterior Trim (8450)
 • Projection is 1 3/8"
 • 8350 same on both sides

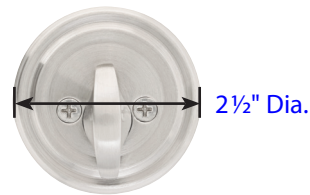

Interior Trim (8450)
 • Projection is 1 1/4"
 • Thickness is 5/16"

Low Profile Style Deadbolt

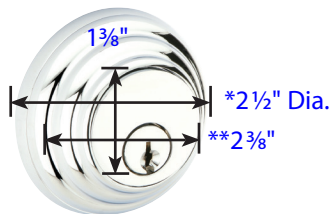

Exterior Trim (8455)
 • * 2 1/2" Diameter with Exterior ring
 • ** 2 3/8" Diameter without Exterior ring
 • Projection with Exterior ring: 7/8"
 • Projection without Exterior ring: 5/8"
 • 8355 same both sides

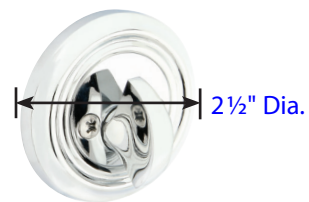

Interior Trim (8455)
 • Projection is 1 1/4"
 • Thickness is 5/16"

Rope Style Deadbolt

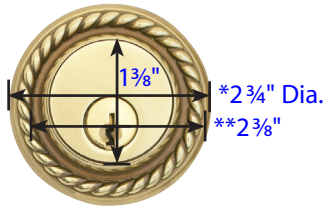

- Exterior Trim (8464)
- * 2 1/2" Diameter with Exterior ring
 - ** 2 3/8" Diameter without Exterior ring
 - Projection with ext. ring: 1 1/16"
 - Projection without ext. ring: 1/2"
 - 8364 same both sides

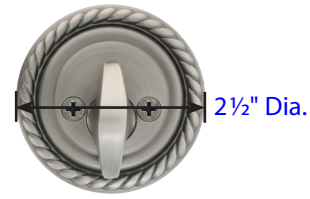

- Interior Trim (8464)
- Projection is 1 1/4"
 - Thickness is 5/16"

#8 Style Deadbolt

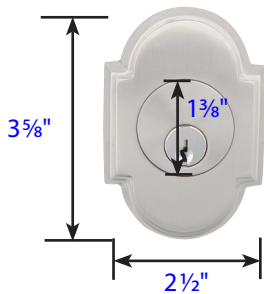

- Exterior Trim (8466)
- Projection is 1/2"
 - 8366 same on both sides

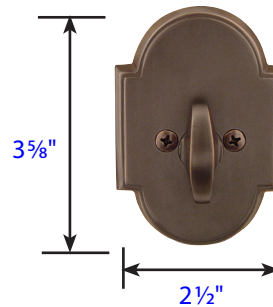

- Interior Trim (8466)
- Projection is 1 1/4"
 - Thickness is 5/16"

Rectangular Style Deadbolt

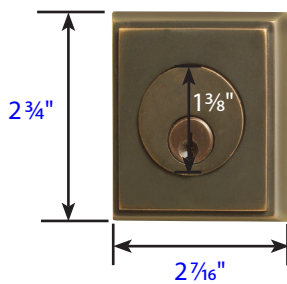

- Exterior Trim (8468)
- Projection is 9/16"
 - 8368 same on both sides

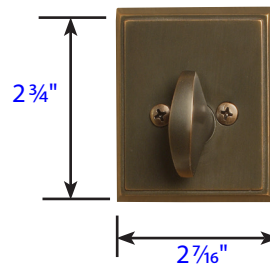

- Interior Trim (8468)
- Projection is 1 1/4"
 - Thickness is 9/32"

Knoxville Style Deadbolt

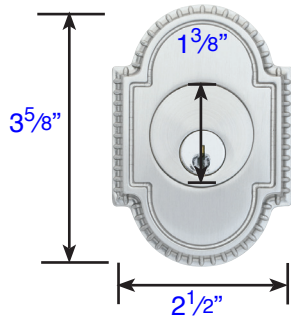

Exterior Trim (8459)
 • Projection is 1/2"
 • 8359 same on both sides

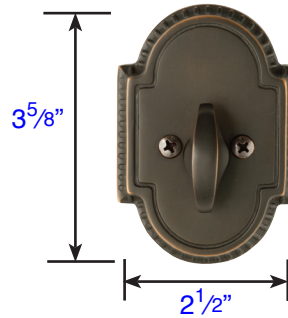

Interior Trim (8459)
 • Projection is 1 1/4"
 • Thickness is 1/2"

Arts & Crafts Style Deadbolt

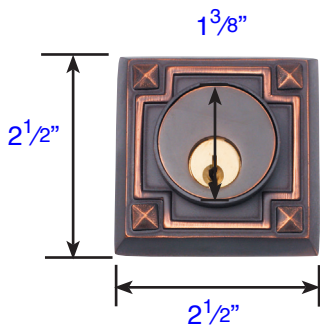

Exterior Trim (8454)
 • Projection is 9/16"
 • 8354 same on both sides

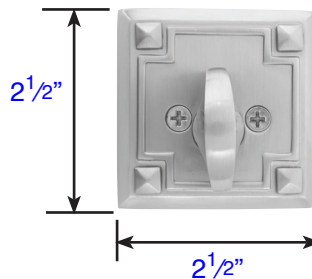

Interior Trim (8454)
 • Projection is 1 1/4"
 • Thickness is 5/16"

Saratoga Style Deadbolt

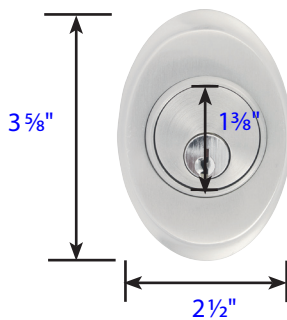

Exterior Trim (8458)
 • Projection is 1/2"
 • 8358 same on both sides

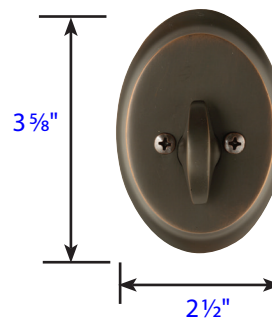

Interior Trim (8458)
 • Projection is 1 1/4"
 • Thickness is 1/2"

Bronze Regular Style Deadbolt

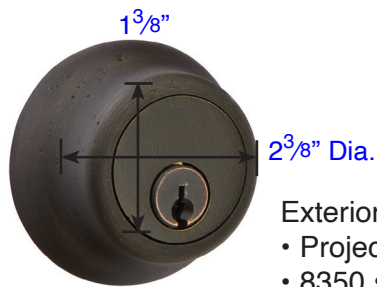

Exterior Trim (8450)
 • Projection is 1"
 • 8350 same on both sides



Interior Trim (8450)
 • Projection is 1 1/4"
 • Thickness is 5/16"

#1 Style Plate with Flap Deadbolt

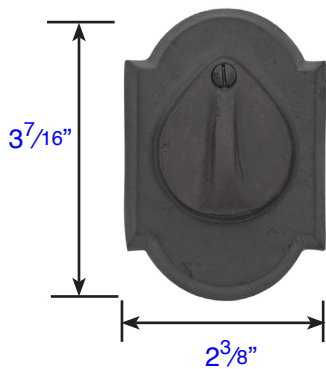

Exterior Trim (8457)
 • Projection is 1 3/16"
 • 8357 same on both sides

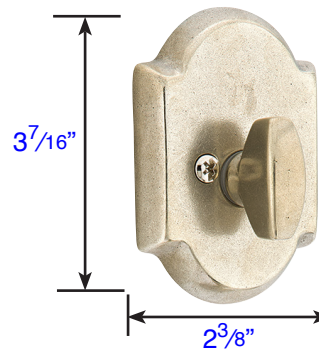

Interior Trim (8457)
 • Projection is 1 1/4"
 • Thickness is 1/2"

#3 Style Plate with Flap Deadbolt

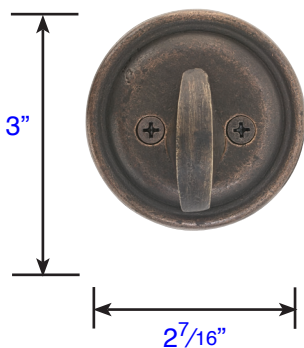

Exterior Trim (8465)
 • Projection is 1 1/16"
 • 8365 same on both sides

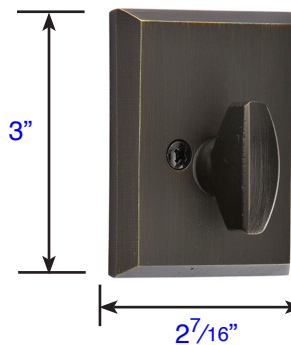

Interior Trim (8465)
 • Projection is 1 1/4"
 • Thickness is 1/2"

Sandcast Bronze Rustic Modern Rectangular Style Deadbolt

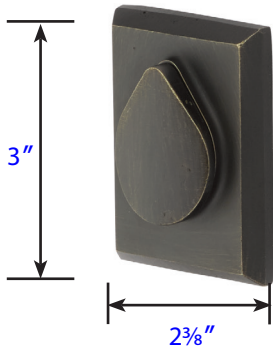

Exterior Trim (8477)
 • Projection is $1\frac{1}{16}$ "
 • 8377 same on both sides

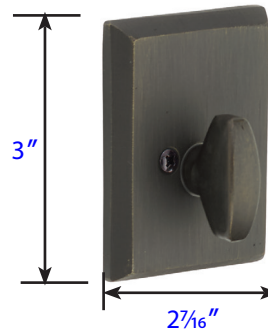

Interior Trim (8477)
 • Projection is $1\frac{1}{4}$ "
 • Thickness is $\frac{1}{2}$ "

#4 Style Plate with Flap Deadbolt (Discontinued)

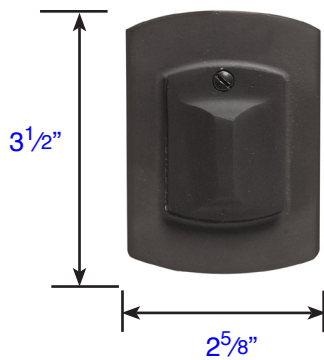

Exterior Trim (8474)
 • Projection is $1\frac{1}{16}$ "
 • 8374 same on both sides

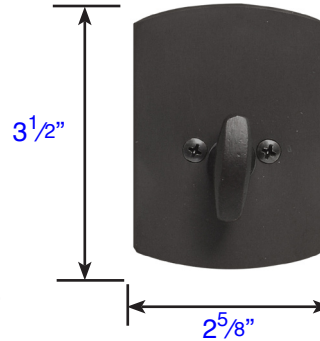

Interior Trim (8474)
 • Projection is $1\frac{1}{4}$ "
 • Thickness is $\frac{3}{8}$ "

#6 Ridgemont Style Plate with Flap Deadbolt

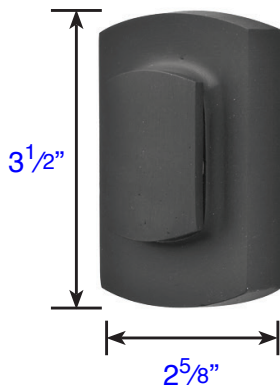

Exterior Trim (8476)
 • Projection is $1\frac{5}{16}$ "
 • 8376 same on both sides

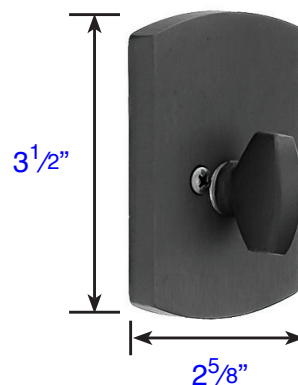

Interior Trim (8476)
 • Projection is $1\frac{5}{16}$ "
 • Thickness is $\frac{1}{2}$ "

Tuscany Style Deadbolt

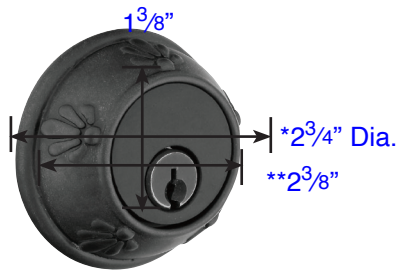

- Exterior Trim (8456)
- * 2³/₄" Diameter with Exterior ring
 - ** 2³/₈" Diameter without Exterior ring
 - Projection with ext. ring: 1"
 - Projection without ext. ring: 1¹/₁₆"
 - 8356 same both sides

- Interior Trim (8456)
- Projection is 1¹/₄"
 - Thickness is 5⁵/₁₆"

Tuscany Classic Style Deadbolt

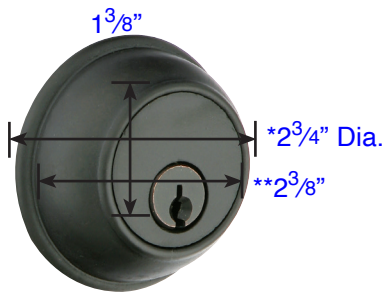

- Exterior Trim (8471)
- * 2³/₄" Diameter with Exterior ring
 - ** 2³/₈" Diameter without Exterior ring
 - Projection with ext. ring: 1"
 - Projection without ext. ring: 1¹/₁₆"
 - 8371 same both sides

- Interior Trim (8471)
- Projection is 1¹/₄"
 - Thickness is 5⁵/₁₆"

Octagon Style Deadbolt

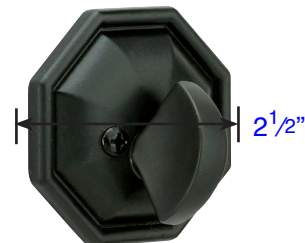
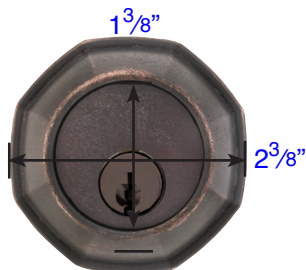

- Exterior Trim (8460)
- Projection is 3³/₄"
 - 8360 same on both sides

- Interior Trim (8460)
- Projection is 1¹/₄"
 - Thickness is 5⁵/₁₆"

#11 Style Deadbolt

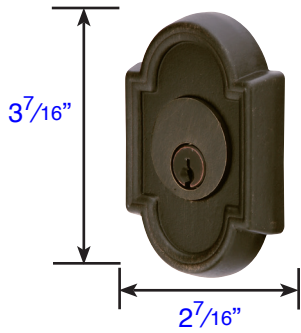

Exterior Trim (8472)
• Projection is 11/16"
8372 same both sides

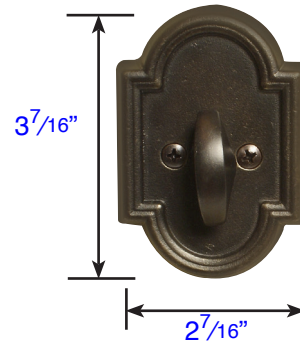

Interior Trim (8472)
• Projection is 1 1/4"
• Thickness is 9/16"

#14 Style Deadbolt

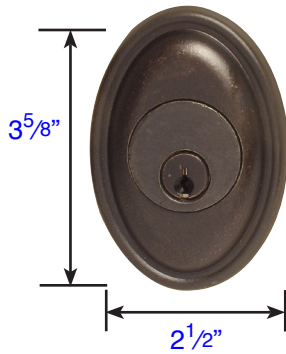

Exterior Trim (8473)
• Projection is 11/16"
8373 same both sides

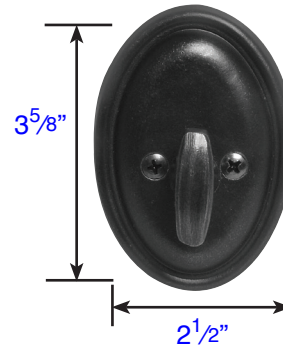

Interior Trim (8473)
• Projection is 1 1/4"
• Thickness is 9/16"

#1 Style Deadbolt

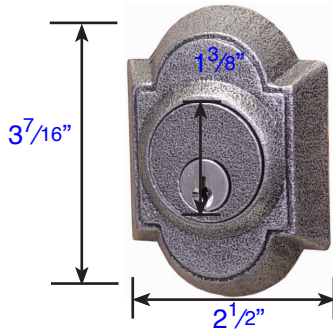

Exterior Trim (8461)
 • Projection is $\frac{5}{8}$ "
 • 8361 same on both sides

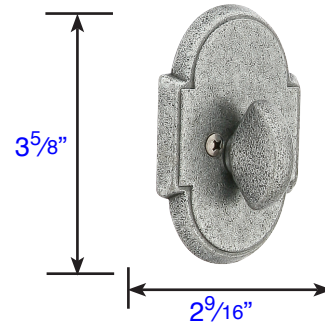

Interior Trim (8461)
 • Projection is $1\frac{1}{4}$ "
 • Thickness is $\frac{1}{4}$ "

#2 Style Deadbolt

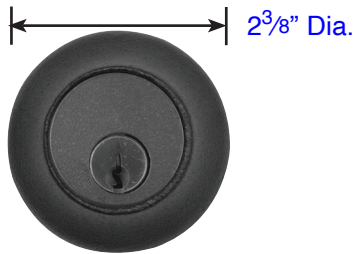

Exterior Trim (8452)
 • Projection is $2\frac{3}{8}$ "
 • 8350 same on both sides

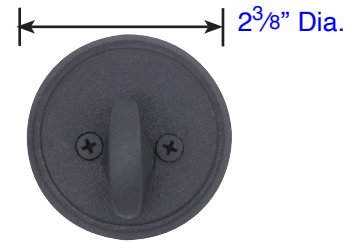

Interior Trim (8452)
 • Projection is $1\frac{1}{4}$ "
 • Thickness is $\frac{1}{4}$ "

#3 Style Deadbolt

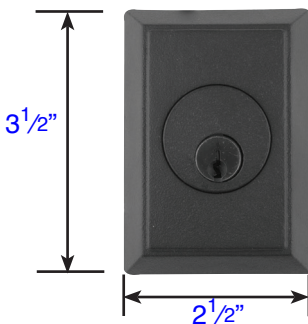

Exterior Trim (8463)
 • Projection is $2\frac{1}{2}$ "
 • 8363 same on both sides

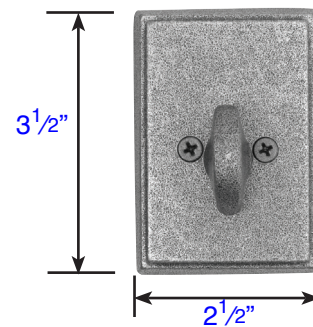

Interior Trim (8463)
 • Projection is $1\frac{1}{4}$ "
 • Thickness is $\frac{1}{4}$ "

Regular Sandcast Bronze (8450)

STANDARD DOOR THICKNESS: 1-1/4" - 1-3/4"	EXTENDED DOOR THICKNESS: 1-7/8" - 2"	EXTENDED DOOR THICKNESS: 2-1/8" - 2-5/8"	EXTENDED DOOR THICKNESS: 2-3/4" - 2-7/8"
• Single cylinder tailpiece	• Single cylinder tailpiece	• Long single cylinder tailpiece	• Extra long single cylinder tailpiece
• 2-1/4" + 2-1/2" screws	• 2-1/2" screws for 1-7/8" door	• 3" screws for 2-1/8" - 2-3/8" door	• 3-1/2" screws
• Deadbolt strike plate	• 3" screws for 2" door	• 3-1/2" screws for 2-1/2" - 2-5/8" door	• Deadbolt strike plate
• Deadbolt understrike plate	• Deadbolt strike plate	• Deadbolt strike plate	• Deadbolt understrike plate
	• Deadbolt understrike plate	• Deadbolt understrike plate	

#1 sandcast bronze (8457), Brass Regular (8450), Wrought Steel #2 (8452)

STANDARD DOOR THICKNESS: 1-1/4" - 1-7/8"	EXTENDED DOOR THICKNESS: 2"	EXTENDED DOOR THICKNESS: 2-1/8" - 2-3/4"	EXTENDED DOOR THICKNESS: 2-7/8" - 3"
• Single cylinder tailpiece	• Single cylinder tailpiece	• Long single cylinder tailpiece	• Extra long single cylinder tailpiece
• 2-1/4" screws	• 2-1/2" screws	• 3" screws for 2-1/8" - 2-1/2" door	• 3-1/2" screws
• Deadbolt strike plate	• Deadbolt strike plate	• 3-1/2" screws for 2-5/8" - 2-3/4" door	• Deadbolt strike plate
• Deadbolt understrike plate	• Deadbolt understrike plate	• Deadbolt strike plate	• Deadbolt understrike plate
		• Deadbolt understrike plate	

Rustic modern rectangular (8477), #3 Sandcast bronze (8465), Quincy (8478)*

STANDARD DOOR THICKNESS: 1-1/4" - 1-7/8"	EXTENDED DOOR THICKNESS: 2"	EXTENDED DOOR THICKNESS: 2-1/8" - 2-3/4"	EXTENDED DOOR THICKNESS: 2-7/8" - 3"
• Single cylinder tailpiece	• Single cylinder tailpiece	• Long single cylinder tailpiece	• Extra long single cylinder tailpiece
• 2-1/4" screws	• 2-1/2" screws	• 2-1/2" screws for 2-1/8" door	• 3-1/2" screws
• Deadbolt strike plate	• Deadbolt strike plate	• 3" screws for 2-1/4" - 2-5/8" door	• Deadbolt strike plate
• Deadbolt understrike plate	• Deadbolt understrike plate	• 3-1/2" screws for 2-3/4" door	• Deadbolt understrike plate
		• Deadbolt strike plate	
		• Deadbolt understrike plate	

Knoxville (8459)*, Saratoga (8458)*, Square (8469)*, Ridgemont Sandcast Bronze (8476), Octagon Tuscany (8460), Modern (8467)*, Tuscany Bronze (8456)*, Classic Tuscany Bronze (8471)*

STANDARD DOOR THICKNESS: 1-3/8" - 1-7/8"	EXTENDED DOOR THICKNESS: 2" - 2-1/8"	EXTENDED DOOR THICKNESS: 2-1/4" - 2-7/8"	EXTENDED DOOR THICKNESS: 3"
• Single cylinder tailpiece	• Single cylinder tailpiece	• Long single cylinder tailpiece	• Extra long single cylinder tailpiece
• 2-1/4" screws	• 2-1/2" screws	• 3" screws for 2-1/4" - 2-5/8" door	• 3-1/2" screws
• Deadbolt strike plate	• Deadbolt strike plate	• 3-1/2" screws for 2-3/4" - 2-7/8" door	• Deadbolt strike plate
• Deadbolt understrike plate	• Deadbolt understrike plate	• Deadbolt strike plate	• Deadbolt understrike plate
		• Deadbolt understrike plate	

*Deadbolt Ring/Collar sent for thin door (up to 1-3/4" door)

Wrought Steel #1 (8461), Neos (8475)*, #14 Tuscany Bronze (8473)

STANDARD DOOR THICKNESS: 1-3/8" - 1-7/8"	EXTENDED DOOR THICKNESS: 2" - 2-1/8"	EXTENDED DOOR THICKNESS: 2-1/4" - 2-7/8"	EXTENDED DOOR THICKNESS: 3" - 3-1/4"
• Single cylinder tailpiece	• Single cylinder tailpiece	• Long single cylinder tailpiece	• Extra long single cylinder tailpiece
• 2-1/4" screws	• 2-1/2" screws	• 2-1/2" screws for 2-1/4" door	• 3-1/2" screws
• Deadbolt strike plate	• Deadbolt strike plate	• 3" screws for 2-3/8" - 2-3/4" door	• Deadbolt strike plate
• Deadbolt understrike plate	• Deadbolt understrike plate	• 3-1/2" screws for 2-7/8" door	• Deadbolt understrike plate
		• Deadbolt strike plate	
		• Deadbolt understrike plate	

Urban Modern (8426)*, #11 Tuscany Bronze (8472), Modern Disc (8423)*, Arts & Crafts (8454)*

STANDARD DOOR THICKNESS: 1-3/8" - 1-7/8"	EXTENDED DOOR THICKNESS: 2" - 2-1/8"	EXTENDED DOOR THICKNESS: 2-1/4" - 2-7/8"	EXTENDED DOOR THICKNESS: 3" - 3-1/4"
• Single cylinder tailpiece	• Single cylinder tailpiece	• Long single cylinder tailpiece	• Extra long single cylinder tailpiece
• 2-1/4" screws	• 2-1/2" screws	• 2-1/2" screws for 2-1/4" door	• 3-1/2" screws
• Deadbolt strike plate	• Deadbolt strike plate	• 3" screws for 2-3/8" - 2-3/4" door	• Deadbolt strike plate
• Deadbolt understrike plate	• Deadbolt understrike plate	• 3-1/2" screws for 2-7/8" door	• Deadbolt understrike plate
		• Deadbolt strike plate	
		• Deadbolt understrike plate	

Low Profile (8455)*, Wrought Steel #3 (8463), Rectangular (8468)*, Rope (8464)*, Wilshire (8479)*, #8 (8466)*

STANDARD DOOR THICKNESS: 1-3/8" - 2"	EXTENDED DOOR THICKNESS: 2-1/8"	EXTENDED DOOR THICKNESS: 2-1/4" - 2-7/8"	EXTENDED DOOR THICKNESS: 3" - 3-1/4"
• Single cylinder tailpiece	• Single cylinder tailpiece	• Long single cylinder tailpiece	• Extra long single cylinder tailpiece
• 2-1/4" screws	• 2-1/2" screws	• 2-1/2" screws for 2-1/4" door	• 3-1/2" screws
• Deadbolt strike plate	• Deadbolt strike plate	• 3" screws for 2-3/8" - 2-3/4" door	• Deadbolt strike plate
• Deadbolt understrike plate	• Deadbolt understrike plate	• 3-1/2" screws for 2-7/8" door	• Deadbolt understrike plate
		• Deadbolt strike plate	
		• Deadbolt understrike plate	

*Deadbolt Ring/Collar sent for thin door (up to 1-3/4" door)

SS Round (S50001)*

STANDARD DOOR THICKNESS: 1-3/8" - 1-7/8"	EXTENDED DOOR THICKNESS: 2"	EXTENDED DOOR THICKNESS: 2-1/8" - 2-3/4"	EXTENDED DOOR THICKNESS: 2-7/8" - 3"
<ul style="list-style-type: none"> Single cylinder tailpiece 	<ul style="list-style-type: none"> Single cylinder tailpiece 	<ul style="list-style-type: none"> Long single cylinder tailpiece 	<ul style="list-style-type: none"> Extra long single cylinder tailpiece
<ul style="list-style-type: none"> 2-1/4" socket cap screws 	<ul style="list-style-type: none"> 2-1/2" socket cap screws 	<ul style="list-style-type: none"> 2-1/2" socket cap screws for 2-1/8" door 	<ul style="list-style-type: none"> 3-1/2" socket cap screws
<ul style="list-style-type: none"> Deadbolt strike plate 	<ul style="list-style-type: none"> Deadbolt strike plate 	<ul style="list-style-type: none"> 3" socket cap screws for 2-1/4" - 2-5/8" door 	<ul style="list-style-type: none"> Deadbolt strike plate
<ul style="list-style-type: none"> Deadbolt understrike plate 	<ul style="list-style-type: none"> Deadbolt understrike plate 	<ul style="list-style-type: none"> 3-1/2" socket cap screws for 2-3/4" door Deadbolt strike plate Deadbolt understrike plate 	<ul style="list-style-type: none"> Deadbolt understrike plate

SS Square (S50003)*

STANDARD DOOR THICKNESS: 1-3/8" - 1-7/8"	EXTENDED DOOR THICKNESS: 2" - 2-1/8"	EXTENDED DOOR THICKNESS: 2-1/4" - 2-7/8"	EXTENDED DOOR THICKNESS: 3"
<ul style="list-style-type: none"> Single cylinder tailpiece 	<ul style="list-style-type: none"> Single cylinder tailpiece 	<ul style="list-style-type: none"> Long single cylinder tailpiece 	<ul style="list-style-type: none"> Extra long single cylinder tailpiece
<ul style="list-style-type: none"> 2-1/4" socket cap screws 	<ul style="list-style-type: none"> 2-1/2" socket cap screws 	<ul style="list-style-type: none"> 3" socket cap screws for 2-1/4" - 2-5/8" door 	<ul style="list-style-type: none"> 3-1/2" socket cap screws
<ul style="list-style-type: none"> Deadbolt strike plate 	<ul style="list-style-type: none"> Deadbolt strike plate 	<ul style="list-style-type: none"> 3-1/2" socket cap screws for 2-3/4" - 2-7/8" door 	<ul style="list-style-type: none"> Deadbolt strike plate
<ul style="list-style-type: none"> Deadbolt understrike plate 	<ul style="list-style-type: none"> Deadbolt understrike plate 	<ul style="list-style-type: none"> Deadbolt strike plate Deadbolt understrike plate 	<ul style="list-style-type: none"> Deadbolt understrike plate

SS Modern Disc (S50004)*

STANDARD DOOR THICKNESS: 1-3/8" - 2"	EXTENDED DOOR THICKNESS: 2-1/8" - 2-1/4"	EXTENDED DOOR THICKNESS: 2-3/8" - 3"	EXTENDED DOOR THICKNESS: 3-1/8" - 3-1/4"
<ul style="list-style-type: none"> Single cylinder tailpiece 	<ul style="list-style-type: none"> Single cylinder tailpiece 	<ul style="list-style-type: none"> Long single cylinder tailpiece 	<ul style="list-style-type: none"> Extra long single cylinder tailpiece
<ul style="list-style-type: none"> 2-1/4" socket cap screws 	<ul style="list-style-type: none"> 2-1/2" socket cap screws 	<ul style="list-style-type: none"> 3" socket cap screws for 2-3/8" - 2-3/4" door 	<ul style="list-style-type: none"> 3-1/2" socket cap screws
<ul style="list-style-type: none"> Deadbolt strike plate 	<ul style="list-style-type: none"> Deadbolt strike plate 	<ul style="list-style-type: none"> 3-1/2" socket cap screws for 2-7/8" - 3" door 	<ul style="list-style-type: none"> Deadbolt strike plate
<ul style="list-style-type: none"> Deadbolt understrike plate 	<ul style="list-style-type: none"> Deadbolt understrike plate 	<ul style="list-style-type: none"> Deadbolt strike plate Deadbolt understrike plate 	<ul style="list-style-type: none"> Deadbolt understrike plate

*Deadbolt Ring/Collar sent for thin door (up to 1-3/4" door)

Regular sandcast bronze (8350)

STANDARD DOOR THICKNESS: 1-1/4" - 1-3/4"	EXTENDED DOOR THICKNESS: 1-7/8" - 2-1/4"
• Long double cylinder tailpiece	• Long double cylinder tailpiece
• 3" screws	• 3-1/2" screws
• Deadbolt strike plate	• Deadbolt strike plate
• Deadbolt understrike plate	• Deadbolt understrike plate

Wrought Steel #2 (8350)

STANDARD DOOR THICKNESS: 1-1/4" - 1-3/4"	EXTENDED DOOR THICKNESS: 1-7/8"	EXTENDED DOOR THICKNESS: 2" - 2-1/2"
• Double cylinder tailpiece	• Long double cylinder tailpiece	• Long double cylinder tailpiece
• 2-1/2"+ 3" screws	• 3" screws	• 3-1/2" screws
• Deadbolt strike plate	• Deadbolt strike plate	• Deadbolt strike plate
• Deadbolt understrike plate	• Deadbolt understrike plate	• Deadbolt understrike plate

Brass Regular (8350)

STANDARD DOOR THICKNESS: 1-1/4" - 1-3/4"	EXTENDED DOOR THICKNESS: 1-7/8" - 2"	EXTENDED DOOR THICKNESS: 2" - 2-1/2"
• Double cylinder tailpiece	• Long double cylinder tailpiece	• Long double cylinder tailpiece
• 2-1/2"+ 3" screws	• 3" screws	• 3-1/2" screws
• Deadbolt strike plate	• Deadbolt strike plate	• Deadbolt strike plate
• Deadbolt understrike plate	• Deadbolt understrike plate	• Deadbolt understrike plate

Octagon Tuscany (8360), Wrought Steel #1 (8361)

STANDARD DOOR THICKNESS: 1-1/2" - 1-3/4"	EXTENDED DOOR THICKNESS: 1-7/8" - 2"	EXTENDED DOOR THICKNESS: 2" - 2-3/4"
• Double cylinder tailpiece	• Double cylinder tailpiece	• Long double cylinder tailpiece
• 2-1/2" screws	• 3" screws	• 3" screws for 2-1/8" - 2-1/4" door
• Deadbolt strike plate	• Deadbolt strike plate	• 3-1/2" screws for 2-3/8" - 2-3/4" door
• Deadbolt understrike plate	• Deadbolt understrike plate	• Deadbolt strike plate
		• Deadbolt understrike plate

*Deadbolt Ring/Collar sent for thin door (up to 1-3/4" door)

Tuscany Bronze (8356)*, Classic Tuscany Bronze (8371)*

STANDARD DOOR THICKNESS: 1-1/4" - 1-3/4"	EXTENDED DOOR THICKNESS: 1-7/8" - 2-1/8"	EXTENDED DOOR THICKNESS: 2-1/4" - 2-3/4"
• Double cylinder tailpiece	• Double cylinder tailpiece	• Long double cylinder tailpiece
• 2-1/4" + 2-1/2" screws	• 3" screws	• 3" screws for 2-1/4" door
• Deadbolt strike plate	• Deadbolt strike plate	• 3-1/2" screws for 2-3/8" - 2-3/4" door
• Deadbolt understrike plate	• Deadbolt understrike plate	• Deadbolt strike plate
		• Deadbolt understrike plate

Square (8369)*, Rectangular (8368)*

STANDARD DOOR THICKNESS: 1-1/4" - 1-3/4"	EXTENDED DOOR THICKNESS: 1-7/8" - 2-1/8"	EXTENDED DOOR THICKNESS: 2-1/4" - 2-7/8"
• Double cylinder tailpiece	• Double cylinder tailpiece	• Long double cylinder tailpiece
• 2-1/4" + 2-1/2" screws	• 2-1/2" screws for 1-7/8" door	• 3" screws for 2-1/4" - 2-3/8" door
• Deadbolt strike plate	• 3" screws for 2" - 2-1/8" door	• 3-1/2" screws for 2-1/2" - 2-7/8" door
• Deadbolt understrike plate	• Deadbolt strike plate	• Deadbolt strike plate
	• Deadbolt understrike plate	• Deadbolt understrike plate

#1 Sandcast Bronze (8357)

STANDARD DOOR THICKNESS: 1-5/8" - 1-7/8"	EXTENDED DOOR THICKNESS: 2" - 2-1/8"	EXTENDED DOOR THICKNESS: 2-1/4" - 2-7/8"
• Double cylinder tailpiece	• Double cylinder tailpiece	• Long double cylinder tailpiece
• 2-1/2" screws	• 3" screws	• 3" screws for 2-1/4" - 2-3/8" door
• Deadbolt strike plate	• Deadbolt strike plate	• 3-1/2" screws for 2-1/2" - 2-7/8" door
• Deadbolt understrike plate	• Deadbolt understrike plate	• Deadbolt strike plate
		• Deadbolt understrike plate

Low Profile (8355)*, Modern (8367)*, Arts & Crafts (8354)*, Rope (8364)*

STANDARD DOOR THICKNESS: 1-1/4" - 1-3/4"	EXTENDED DOOR THICKNESS: 1-7/8" - 2-1/4"	EXTENDED DOOR THICKNESS: 2-3/8" - 2-7/8"
• Double cylinder tailpiece	• Double cylinder tailpiece	• Long double cylinder tailpiece
• 2-1/4" + 2-1/2" screws	• 2-1/2" screws for 1-7/8" door	• 3" screws for 2-3/8" door
• Deadbolt strike plate	• 3" screws for 2" - 2-1/4" door	• 3-1/2" screws for 2-1/2" - 2-7/8" door
• Deadbolt understrike plate	• Deadbolt strike plate	• Deadbolt strike plate
	• Deadbolt understrike plate	• Deadbolt understrike plate

*Deadbolt Ring/Collar sent for thin door (up to 1-3/4" door)

Ridgemont Sandcast Bronze (8376), Wrought Steel #3 (8363), #3 Sandcast Bronze (8365), Rustic Modern Rectangular (8377)

STANDARD DOOR THICKNESS: 1-3/4" - 1-7/8"	EXTENDED DOOR THICKNESS: 2" - 2-1/4"	EXTENDED DOOR THICKNESS: 2-3/8" - 2-7/8"
• Double cylinder tailpiece	• Double cylinder tailpiece	• Long double cylinder tailpiece
• 2-1/2" screws	• 3" screws	• 3" screws for 2-3/8" door
• Deadbolt strike plate	• Deadbolt strike plate	• 3-1/2" screws for 2-1/2" - 2-7/8" door
• Deadbolt understrike plate	• Deadbolt understrike plate	• Deadbolt strike plate
		• Deadbolt understrike plate

#8 (8366)*

STANDARD DOOR THICKNESS: 1-3/8" - 1-3/4"	EXTENDED DOOR THICKNESS: 1-7/8" - 2-1/4"	EXTENDED DOOR THICKNESS: 2-3/8" - 3"
• Double cylinder tailpiece	• Double cylinder tailpiece	• Long double cylinder tailpiece
• 2-1/4" screws	• 2-1/2" screws for 1-7/8" - 2" door	• 3" screws for 2-3/8" door
• Deadbolt strike plate	• 3" screws for 2-1/8" - 2-1/4" door	• 3-1/2" screws for 2-1/2" - 3" door
• Deadbolt understrike plate	• Deadbolt strike plate	• Deadbolt strike plate
	• Deadbolt understrike plate	• Deadbolt understrike plate

Wilshire (8379)*, Urban Modern (8326)*, Modern Disc (8323)*, Neos (8375)*, Quincy (8378)*, Saratoga (8358)*, Knoxville (8359)*

STANDARD DOOR THICKNESS: 1-1/2" - 1-3/4"	EXTENDED DOOR THICKNESS: 1-7/8" - 2-3/8"	EXTENDED DOOR THICKNESS: 2-1/2" - 3"
• Double cylinder tailpiece	• Double cylinder tailpiece	• Long double cylinder tailpiece
• 2-1/4" screws	• 2-1/2" screws for 1-7/8" - 2" door	• 3" screws for 2-1/2" door
• Deadbolt strike plate	• 3" screws for 2-1/8" - 2-3/8" door	• 3-1/2" screws for 2-5/8" - 3" door
• Deadbolt understrike plate	• Deadbolt strike plate	• Deadbolt strike plate
		• Deadbolt understrike plate

#14 Tuscany Bronze (8373), #11 Tuscany Bronze (8372)

STANDARD DOOR THICKNESS: 2" - 2-3/8"	EXTENDED DOOR THICKNESS: 2-1/2" - 3"
• Double cylinder tailpiece	• Double cylinder tailpiece
• 2-1/2" screws for 2" - 2-1/8" door	• 3" screws for 2-1/2" - 2-5/8" door
• 3" screws for 2-1/4" - 2-3/8" door	• 3-1/2" screws for 2-3/4" - 3" door
• Deadbolt strike plate	• Deadbolt strike plate
• Deadbolt understrike plate	• Deadbolt understrike plate

*Deadbolt Ring/Collar sent for thin door (up to 1-3/4" door)

SS Round (S50002)*

STANDARD DOOR THICKNESS: 1-1/4" - 1-3/4"	EXTENDED DOOR THICKNESS: 1-7/8" - 2"	EXTENDED DOOR THICKNESS: 2" - 2-3/4"
• Double cylinder tailpiece	• Double cylinder tailpiece	• Long double cylinder tailpiece
• 2-1/2" socket cap screws	• 3" socket cap screws	• 3" socket cap screws for 2-1/8" - 2-1/4" door
• Deadbolt strike plate	• Deadbolt strike plate	• 3-1/2" socket cap screws for 2-3/8" - 2-3/4" door
• Deadbolt understrike plate	• Deadbolt understrike plate	• Deadbolt strike plate
		• Deadbolt understrike plate

SS Square (S50023)*

STANDARD DOOR THICKNESS: 1-1/4" - 1-3/4"	EXTENDED DOOR THICKNESS: 1-7/8" - 2-1/8"	EXTENDED DOOR THICKNESS: 2-1/4" - 2-7/8"
• Double cylinder tailpiece	• Double cylinder tailpiece	• Long double cylinder tailpiece
• 2-1/4" socket cap screws	• 2-1/2" socket cap screws for 1-7/8" door	• 3" socket cap screws for 2-1/4" - 2-3/8" door
• Deadbolt strike plate	• 3" socket cap screws for 2" - 2-1/8" door	• 3-1/2" socket cap screws for 2-1/2" - 2-7/8" door
• Deadbolt understrike plate	• Deadbolt strike plate	• Deadbolt strike plate
	• Deadbolt understrike plate	• Deadbolt understrike plate

SS Modern Disc (S50024)*

STANDARD DOOR THICKNESS: 1-1/4" - 1-3/4"	EXTENDED DOOR THICKNESS: 1-7/8" - 2-3/8"	EXTENDED DOOR THICKNESS: 2-1/2" - 3"
• Double cylinder tailpiece	• Double cylinder tailpiece	• Long double cylinder tailpiece
• 2-1/4" socket cap screws	• 2-1/2" socket cap screws for 1-7/8" - 2" door	• 3" socket cap screws for 2-1/2" door
• Deadbolt strike plate	• 3" socket cap screws for 2-1/8" - 2-3/8" door	• 3-1/2" socket cap screws for 2-5/8" - 3" door
• Deadbolt understrike plate	• Deadbolt strike plate	• Deadbolt strike plate
		• Deadbolt understrike plate

*Deadbolt Ring/Collar sent for thin door (up to 1-3/4" door)

Wrought Steel #3 (8553), Brass Regular (8550), Regular Sandcast Bronze (8550), Rectangular (8568), Wrought Steel #1 (8551), Rope (8564), Wrought Steel #2 (8552)

Quincy (8578), Knoxville (8559)

STANDARD DOOR THICKNESS: 1-1/2" - 2"	EXTENDED DOOR THICKNESS: 2-1/8" - 3"
• Small (1") single cylinder tailpiece	• Single cylinder tailpiece
• 1-3/4" screws	• 2-1/4" screws
• Deadbolt strike plate	• Deadbolt strike plate
• Deadbolt understrike plate	• Deadbolt understrike plate

STANDARD DOOR THICKNESS: 1-3/4" - 2-1/2"	EXTENDED DOOR THICKNESS: 2-5/8" - 3-1/2"
• Small (1") single cylinder tailpiece	• Single cylinder tailpiece
• 1-3/4" screws	• 2-1/4" screws
• Deadbolt strike plate	• Deadbolt strike plate
• Deadbolt understrike plate	• Deadbolt understrike plate

#1 Sandcast Bronze (8557), #3 Sandcast Bronze (8565), Saratoga (8558), #14 Tuscany Bronze (8573), #11 Tuscany Bronze (8572)

STANDARD DOOR THICKNESS: 1-1/2" - 2-1/8"	EXTENDED DOOR THICKNESS: 2-1/4" - 3"
• Small (1") single cylinder tailpiece	• Single cylinder tailpiece
• 1-3/4" screws	• 2-1/4" screws
• Deadbolt strike plate	• Deadbolt strike plate
• Deadbolt understrike plate	• Deadbolt understrike plate

SS Round (S50005), SS Square (S50006)

STANDARD DOOR THICKNESS: 1-5/8" - 2-1/4"	EXTENDED DOOR THICKNESS: 2-3/8" - 3-1/4"
• Small (1") single cylinder tailpiece	• Single cylinder tailpiece
• 1-3/4" socket cap screws	• 2-1/4" socket cap screws
• Deadbolt strike plate	• Deadbolt strike plate
• Deadbolt understrike plate	• Deadbolt understrike plate

Neos (8575), Ridgemont Sandcast Bronze (8576), Square (8569), Urban Modern (8526), Modern (8576), Modern Disc (8523)

STANDARD DOOR THICKNESS: 1-5/8" - 2-1/4"	EXTENDED DOOR THICKNESS: 2-3/8" - 3-1/4"
• Small (1") single cylinder tailpiece	• Single cylinder tailpiece
• 1-3/4" screws	• 2-1/4" screws
• Deadbolt strike plate	• Deadbolt strike plate
• Deadbolt understrike plate	• Deadbolt understrike plate

SS Modern Disc (S50007)

STANDARD DOOR THICKNESS: 1-3/4" - 2-3/8"	EXTENDED DOOR THICKNESS: 2-1/2" - 3-1/2"
• Small (1") single cylinder tailpiece	• Single cylinder tailpiece
• 1-3/4" socket cap screws	• 2-1/4" socket cap screws
• Deadbolt strike plate	• Deadbolt strike plate
• Deadbolt understrike plate	• Deadbolt understrike plate

Arts & Crafts (8554), #8 (8566), Octagon Tuscany (8560), Tuscany Bronze (8556), Wilshire (8579)

STANDARD DOOR THICKNESS: 1-3/4" - 2-3/8"	EXTENDED DOOR THICKNESS: 2-1/2" - 3-1/4"
• Small (1") single cylinder tailpiece	• Single cylinder tailpiece
• 1-3/4" screws	• 2-1/4" screws
• Deadbolt strike plate	• Deadbolt strike plate
• Deadbolt understrike plate	• Deadbolt understrike plate

Deadbolt Strike Plates

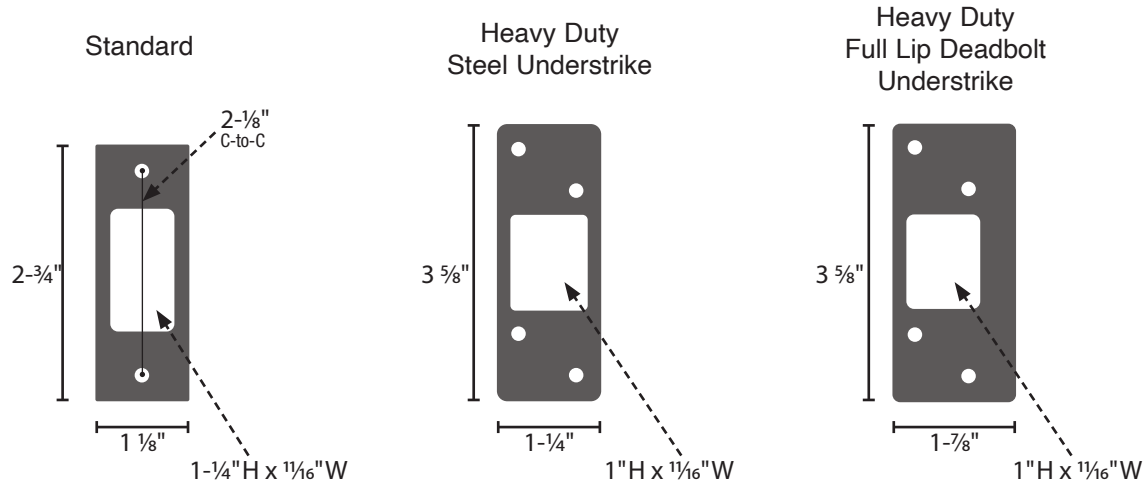

Deadbolt Ring/Collars

